

HILTI

TE 30
TE 30-AVR

English	1
Français	14
Español	28
Português	42

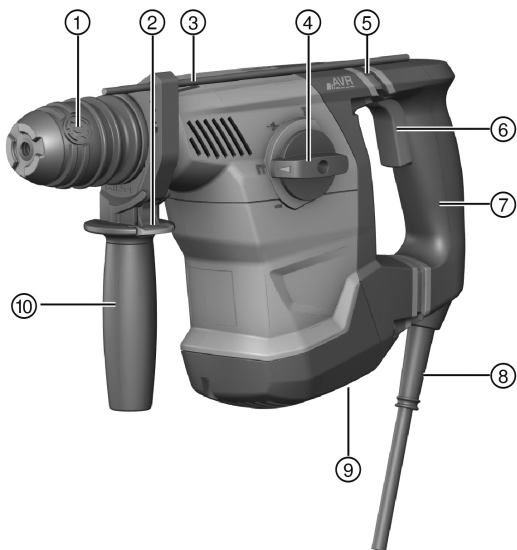



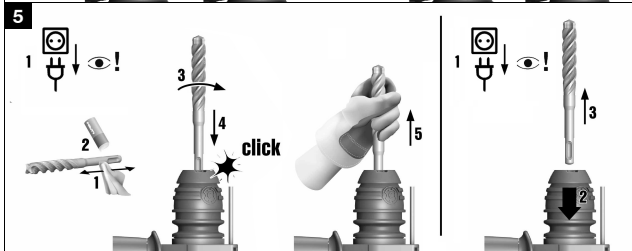
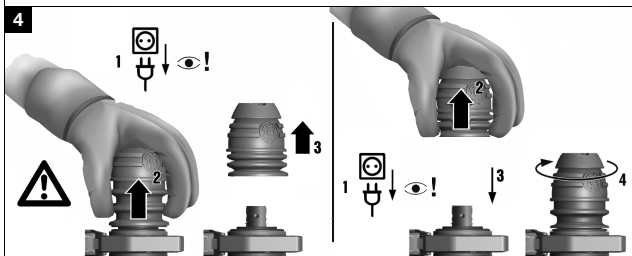
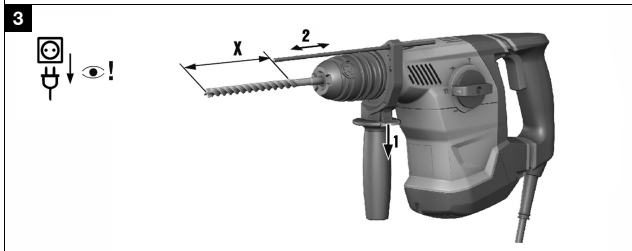
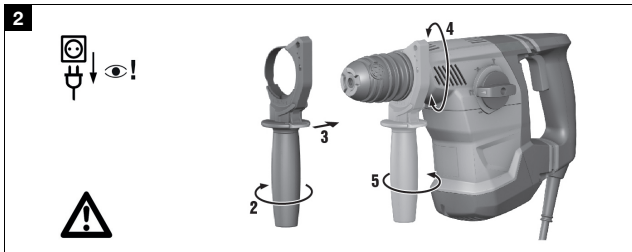

6



		TE 30	TE 30-AVR
		✓	✓
		✓	✓
		-	✓
		-	✓



7

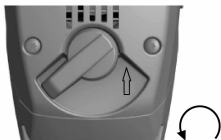
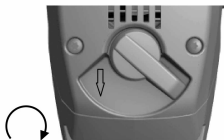

TE 30

TE 30-AVR

en	Original operating instructions	1
fr	Mode d'emploi original	14
es	Manual de instrucciones original	28
pt	Manual de instruções original	42

1 Information about the documentation



1.1 About this documentation

- Read this documentation before initial operation or use. This is a prerequisite for safe, trouble-free handling and use of the product.
- Observe the safety instructions and warnings in this documentation and on the product.
- Always keep the operating instructions with the product and make sure that the operating instructions are with the product when it is given to other persons.

1.2 Explanation of symbols used



1.2.1 Warnings

Warnings alert persons to hazards that may occur when handling or using the product. The following signal words are used in combination with a symbol:

	DANGER! Draws attention to an imminent hazard that will lead to serious personal injury or fatality.
	WARNING! Draws attention to a potential hazard that could lead to serious personal injury or fatality.
	CAUTION! Draws attention to a potentially dangerous situation that could lead to minor personal injury or material damage.



1.2.2 Symbols in the documentation

The following symbols are used in this document:

	Read the operating instructions before use
	Instructions for use and other useful information

1.2.3 Symbols in the illustrations









The following symbols are used in illustrations:

	These numbers refer to the corresponding illustrations found at the beginning of these operating instructions.
3	The numbering reflects the sequence of operations shown in the illustrations and may deviate from the steps described in the text.
	Item reference numbers are used in the overview illustration and refer to the numbers used in the key in the product overview section.
	This symbol is intended to draw special attention to certain points when handling the product.

1.3 Product-dependent symbols

1.3.1 Symbols on the product

The following symbols are used on the product:

	Drilling without hammering
	Drilling with hammering action (hammer drilling)
	Chiseling
	Chisel positioning
	Forward / reverse
	Protection class II – double-insulated (only TE 30)
	Protective earth / ground (only TE 30-AVR)
	Diameter
n_0	Rated speed under no load
/min	Revolutions per minute

1.4 Product information

Hilti products are designed for professional use and may be operated, serviced and maintained only by trained, authorized personnel. This personnel must be informed of any particular hazards that may be encountered. The product and its ancillary equipment can present hazards if used incorrectly by untrained personnel or if used not in accordance with the intended use. The type designation and serial number are stated on the rating plate.

- ▶ Write down the serial number in the table below. You will be required to state the product details when contacting Hilti Service or your local Hilti organization to inquire about the product.

Product information

Combiammer	TE 30 / TE 30-AVR
Generation	02
Serial no.	

1.5 Declaration of conformity

We declare, on our sole responsibility, that the product described here complies with the applicable directives and standards. A copy of the declaration issued by the certification department can be found at the end of this documentation.

The technical documentation is filed and stored here:

Hilti Entwicklungsgesellschaft mbH | Tool Certification | Hiltistrasse 6 | 86916 Kaufering, Germany

2 Safety

2.1 General power tool safety warnings

⚠ WARNING

Read all safety warnings and all instructions. Failure to follow the warnings and instructions may result in electric shock, fire and/or serious injury.

Save all warnings and instructions for future reference.

Work area safety

- ▶ **Keep work area clean and well lit.** Cluttered or dark areas invite accidents.
- ▶ **Do not operate power tools in explosive atmospheres, such as in the presence of flammable liquids, gases or dust.** Power tools create sparks which may ignite the dust or fumes.
- ▶ **Keep children and bystanders away while operating a power tool.** Distractions can cause you to lose control.

Electrical safety

- ▶ **Power tool plugs must match the outlet. Never modify the plug in any way. Do not use any adapter plugs with earthed (grounded) power tools.** Unmodified plugs and matching outlets will reduce risk of electric shock.
- ▶ **Avoid body contact with earthed or grounded surfaces, such as pipes, radiators, ranges and refrigerators.** There is an increased risk of electric shock if your body is earthed or grounded.
- ▶ **Do not expose power tools to rain or wet conditions.** Water entering a power tool will increase the risk of electric shock.
- ▶ **Do not abuse the cord. Never use the cord for carrying, pulling or unplugging the power tool. Keep cord away from heat, oil, sharp edges or moving parts.** Damaged or entangled cords increase the risk of electric shock.
- ▶ **When operating a power tool outdoors, use an extension cord suitable for outdoor use.** Use of a cord suitable for outdoor use reduces the risk of electric shock.
- ▶ **If operating a power tool in a damp location is unavoidable, use a residual current device (RCD) protected supply.** Use of an RCD reduces the risk of electric shock.

Personal safety

- ▶ **Stay alert, watch what you are doing and use common sense when operating a power tool. Do not use a power tool while you are tired or under the influence of drugs, alcohol or medication.** A moment of inattention while operating power tools may result in serious personal injury.
- ▶ **Use personal protective equipment. Always wear eye protection.** Protective equipment such as dust mask, non-skid safety shoes, hard

hat, or hearing protection used for appropriate conditions will reduce personal injuries.

- ▶ **Prevent unintentional starting. Ensure the switch is in the off-position before connecting to power source, picking up or carrying the tool.** Carrying power tools with your finger on the switch or energising power tools that have the switch on invites accidents.
- ▶ **Remove any adjusting key or wrench before turning the power tool on.** A wrench or a key left attached to a rotating part of the power tool may result in personal injury.
- ▶ **Do not overreach. Keep proper footing and balance at all times.** This enables better control of the power tool in unexpected situations.
- ▶ **Dress properly. Do not wear loose clothing or jewellery. Keep your hair, clothing and gloves away from moving parts.** Loose clothes, jewellery or long hair can be caught in moving parts.
- ▶ **If devices are provided for the connection of dust extraction and collection facilities, ensure these are connected and properly used.** Use of dust collection can reduce dust-related hazards.

Power tool use and care

- ▶ Do not force the power tool. Use the correct power tool for your application. The correct power tool will do the job better and safer at the rate for which it was designed.
- ▶ **Do not use the power tool if the switch does not turn it on and off.** Any power tool that cannot be controlled with the switch is dangerous and must be repaired.
- ▶ **Disconnect the plug from the power source from the power tool before making any adjustments, changing accessories, or storing power tools.** Such preventive safety measures reduce the risk of starting the power tool accidentally.
- ▶ **Store idle power tools out of the reach of children and do not allow persons unfamiliar with the power tool or these instructions to operate the power tool.** Power tools are dangerous in the hands of untrained users.
- ▶ **Maintain power tools. Check for misalignment or binding of moving parts, breakage of parts and any other condition that may affect the power tool's operation. If damaged, have the power tool repaired before use.** Many accidents are caused by poorly maintained power tools.
- ▶ **Keep cutting tools sharp and clean.** Properly maintained cutting tools with sharp cutting edges are less likely to bind and are easier to control.
- ▶ **Use the power tool, accessories and tool bits etc. in accordance with these instructions, taking into account the working conditions and the work to be performed.** Use of the power tool for operations different from those intended could result in a hazardous situation.

Service

- ▶ **Have your power tool serviced by a qualified repair person using only identical replacement parts.** This will ensure that the safety of the power tool is maintained.

2.2 Hammer safety warnings

- ▶ **Wear ear protectors.** Exposure to noise can cause hearing loss.
- ▶ **Use auxiliary handles, if supplied with the tool.** Loss of control can cause personal injury.
- ▶ **Hold power tool by insulated gripping surfaces, when performing an operation where the cutting accessory may contact hidden wiring or its own cord.** Cutting accessory contacting a "live" wire may make exposed metal parts of the power tool "live" and could give the operator an electric shock.

2.3 Additional safety instructions for breakers

Personal safety

- ▶ Use the product only when it is in technically faultless condition.
- ▶ Never tamper with or modify the power tool in any way.
- ▶ Use the auxiliary grips supplied with the power tool. Loss of control can cause personal injury.
- ▶ Apply appropriate safety measures at the opposite side of the workpiece in work that involves breaking through. Parts breaking away could fall out and / or fall down causing injury to other persons.
- ▶ Always hold the tool securely with both hands on the insulated grips. Keep the grips clean and dry. If the accessory tool comes into contact with live cables, metal parts of the power tool can also become live, resulting in an electric shock.
- ▶ You and any other persons in the vicinity must wear suitable eye protection, a hard hat, ear protection, protective gloves and respiratory protection while the tool is in use.
- ▶ Wear protective gloves also when changing the accessory tool. Touching the accessory tool can result in cuts and burns.
- ▶ Wear eye protection. Flying fragments can injure the body and eyes.
- ▶ Before starting work, check the hazard class of the dust that will be produced when working. Use an industrial vacuum cleaner with an officially approved protection class in compliance with the locally applicable dust protection regulations. Dust from materials such as lead-based paint, certain types of wood and concrete/masonry/stone containing quartz, minerals or metal can be harmful to health.
- ▶ Make sure that the workplace is well ventilated and, where necessary, wear a respirator appropriate for the type of dust generated. Contact with or inhalation of the dust may cause allergic reactions and/or respiratory or other diseases among operators or bystanders. Certain kinds of dust

are classified as carcinogenic such as oak and beech dust, especially in conjunction with additives for wood conditioning (chromate, wood preservative). Material containing asbestos may be handled only by specialists.

- ▶ Take breaks and do physical exercises to improve the blood circulation in your fingers. Exposure to vibration during long periods of work can lead to disorders of the blood vessels and nervous system in the fingers, hands and wrists.

Electrical safety

- ▶ Before beginning work, check the working area for concealed electric cables or gas and water pipes. External metal parts of the power tool can become live, presenting a risk of electric shock, if you accidentally damage an electric cable.

Careful handling and use of electric tools

- ▶ Wait until the power tool stops completely before you lay it down.

3 Description

3.1 Overview of the product 1

- | | |
|------------------------------------|----------------------------|
| ① Chuck | ⑥ Control switch |
| ② Depth gauge release button | ⑦ Grip |
| ③ Depth gauge | ⑧ Supply cord |
| ④ Function selector switch | ⑨ Forward / reverse switch |
| ⑤ Active Vibration Reduction (AVR) | ⑩ Side handle |

3.2 Intended use

The product described is an electrically powered combihammer. It is designed for drilling in concrete, masonry, wood and metal.

The version with AVR can also be used for light to medium-duty chiseling on masonry and for finishing work on concrete.

- ▶ The tool may be operated only when connected to a power source providing a voltage and frequency in compliance with the information given on the type identification plate.

3.3 Possible misuse

- This product is not suitable for working on hazardous materials.
- This product is not suitable for working in a damp environment.

3.4 AVR option

The product may be optionally equipped with an Active Vibration Reduction (AVR) system, which reduces vibration noticeably.

3.5 Motor protection system

The tool is equipped with a motor protection system. The system monitors current input and motor temperature and thus prevents the tool from overheating.

If the motor is overloaded through application of excessive working pressure, the power tool's performance drops noticeably or it may stall completely.

If the power tool stalls or slows significantly due to overloading, release the pressure applied to the tool and then allow it to run under no load for approx. 30 seconds.

3.6 Items supplied

Rotary hammer, side handle, depth gauge, operating instructions.



Note

For safe, reliable operation, use only genuine Hilti spare parts and accessories. Spare parts, accessories and consumables approved by Hilti for use with this product can be found at your **Hilti Center** or at www.hilti.com.

4 Technical data



Note

For details of the rated voltage, current, frequency and/or input power, please refer to the power tool's country-specific type identification plate.

When powered by a generator or transformer, the generator or transformer's power output must be at least twice the rated input power shown on the rating plate of the power tool. The operating voltage of the transformer or generator must always be within +5% and -15% of the rated voltage of the power tool.

	Model	
	TE 30	TE 30-AVR
Weight	9.0 lb (4.1 kg)	9.3 lb (4.2 kg)
Ø hammer drill bits	1/4 in ... 1 1/8 in	1/4 in ... 1 1/8 in
Ø hammer drill bits	6 mm ... 28 mm	6 mm ... 28 mm
Ø drill bits for wood	3/16 in ... 1 in	3/16 in ... 1 in
Ø drill bits for wood	3 mm ... 25 mm	3 mm ... 25 mm
Ø drill bits for metal	3/16 in ... 1/2 in	3/16 in ... 1/2 in
Ø drill bits for metal	3 mm ... 13 mm	3 mm ... 13 mm

5 Using extension cords

WARNING

A damaged supply cord presents a hazard! Do not touch the supply cord or extension cord if damaged while working. Disconnect the supply cord plug from the power outlet.

- ▶ Check the appliance's supply cord at regular intervals and have it replaced by a qualified specialist if found to be damaged.

- Use only extension cords of a type approved for the application and with conductors of adequate gauge (cross section). The power tool may otherwise suffer a drop in performance and the extension cord may overheat.
- Check the extension cord for damage at regular intervals.
- Replace damaged extension cords.
- When working outdoors, use only extension cords that are approved and correspondingly marked for this application.

Recommended minimum conductor gauge (cross section) and maximum cord length with 120V supply voltage

Extension cords	AWG 16	AWG 14	AWG 12	AWG 10
Extension cord conductor gauge	1,31 mm ²	2,08 mm ²	3,31 mm ²	5,26 mm ²
Extension cord conductor gauge	2,58 kcmil	4,11 kcmil	6,53 kcmil	10,4 kcmil
Extension cord length	25 m	30 m	50 m	100 m
Extension cord length	75 ft	100 ft	150 ft	250 ft

6 Operation

6.1 Preparations at the workplace

CAUTION

Risk of injury! Inadvertent starting of the product.

- ▶ Unplug the supply cord before making adjustments to the power tool or before changing accessories.

Observe the safety instructions and warnings in this documentation and on the product.

6.1.1 Fitting the side handle

1. Release the side handle clamping band by turning the handle grip.
2. Slide the side handle clamping band over the chuck from the front and into the recess provided.
3. Bring the side handle into the desired position.

4. Tighten the side handle clamping band by turning the handle grip.

6.1.2 Adjusting the depth gauge (optional) 3

1. Press the release button on the side handle.
2. Adjust the depth gauge to the desired drilling depth.
3. Release the release button.
4. Check that the side handle is securely attached.

6.1.3 Removing the chuck 4



CAUTION

Risk of injury! The depth gauge, if fitted but not used, may hinder the user.

- ▶ Remove the depth gauge from the tool.



Note

Set the function selector switch to the **T** “Chiseling” position for changing the chuck.

1. Disconnect the supply cord plug from the power outlet.
2. Grip the chuck as shown in the illustration and pull the three chuck release rings upwards.
3. Lift the chuck upwards away from the tool.

6.1.4 Fitting the chuck 4



CAUTION

Risk of injury! The depth gauge, if fitted but not used, may hinder the user.

- ▶ Remove the depth gauge from the tool.



Note

When changing the chuck, set the function selector switch to this position: **T**.

1. Disconnect the supply cord plug from the power outlet.
2. Grip the chuck as shown in the illustration and pull the three chuck release rings upwards.
3. Fit the chuck onto the chuck mount.
4. Rotate the chuck until it engages in position.

6.1.5 Fitting the accessory tool 5

1. Apply a little grease to the connection end of the accessory tool.
 - ◁ Use only genuine **Hilti** grease. Use of the wrong grease can result in damage to the tool.

2. Push the accessory tool into the chuck as far as it will go, turning it and applying light pressure until it engages with an audible click.
3. After fitting the accessory tool, grip it and pull it firmly in order to check that it is securely engaged.
 - ◁ The product is ready for use.

6.1.6 Removing the accessory tool

CAUTION

Risk of injury! The accessory tool gets hot during use.

- ▶ Wear protective gloves when changing the accessory tool.
- ▶ Do not place the hot accessory tool on readily flammable materials.

- ▶ Pull the chuck ring back as far as it will go and remove the accessory tool.

6.2 Types of work

WARNING

A damaged supply cord presents a hazard! Do not touch the supply cord or extension cord if damaged while working. Disconnect the supply cord plug from the power outlet.

- ▶ Check the appliance's supply cord at regular intervals and have it replaced by a qualified specialist if found to be damaged.

Check extension cords at regular intervals and replace them if found to be damaged.

6.2.1 Function selector switch

- ▶ Set the function selector switch to the desired working position.
 - ◁ Do not operate the function selector switch while the motor is running.
- Risk of damage!**

6.2.2 Drilling without hammering

- ▶ Set the function selector switch to this symbol: .

6.2.3 Drilling with hammering action (hammer drilling)

- ▶ Set the function selector switch to this symbol: .

6.2.4 Positioning the chisel (only TE 30-AVR)

CAUTION

Risk of injury! Loss of control over the chisel direction.

- ▶ Do not operate the tool when the selector switch is set to "Chisel positioning". Turn the function selector switch until it engages in the "Chiseling" position.

- ▶ Set the function selector switch to this symbol: 
 - ◀ The chisel can be adjusted to 12 different positions (in 30° increments). This ensures that flat chisels and shaped chisels can always be set to the optimum working position.

6.2.5 Chiseling (only TE 30-AVR)

- ▶ Set the function selector switch to this symbol: 

6.2.6 Forward / reverse

- ▶ Set the forward/reverse switch to the desired direction of rotation.
 - ◀ Do not operate the function selector switch while the motor is running.
Risk of damage!

7 Care and maintenance

WARNING

Danger of electric shock! Carrying out care and maintenance while the supply cord is connected to the power outlet presents a risk of serious injuries including burns.

- ▶ Always unplug the supply cord before carrying out all care and maintenance tasks.

Care

- Carefully remove stubborn dirt from the tool.
- Clean the air vents carefully with a dry brush.
- Use only a slightly damp cloth to clean the casing. Do not use cleaning agents containing silicone as they can attack the plastic parts.

Maintenance

WARNING

Danger of electric shock! Improper repairs to electrical components may lead to serious injuries including burns.

- ▶ Repairs to the electrical section of the tool or appliance may be carried out only by trained electrical specialists.
-
- At regular intervals, check all visible parts and the controls for signs of damage and make sure that they all function correctly.
 - Do not operate the power tool if signs of damage are found or if parts malfunction. Have damage repaired immediately by **Hilti Service**.
 - After cleaning and maintenance, refit all guards or protective devices and check that they function correctly.



Note

To help ensure safe and reliable operation, use only genuine Hilti spare parts and consumables. Spare parts, consumables and accessories approved by Hilti for use with the product can be found at your local **Hilti Center** or online at: **www.hilti.com**







8 Transport and storage

- Do not transport electric tools with accessory tools fitted.
- Always unplug the supply cord before storing an electric tool or appliance.
- Store tools and appliances in a dry place where they cannot be accessed by children or unauthorized persons.
- Check electric tools or appliances for damage after long periods of transport or storage.

9 Troubleshooting

If the trouble you are experiencing is not listed in this table or you are unable to remedy the problem by yourself, please contact **Hilti Service**.

Trouble or fault	Possible cause	Action to be taken
The tool doesn't start or switches itself off during operation.	Interruption in the electric supply.	▶ Plug in another electric tool or appliance and check whether it works.
	The carbon brushes are worn out.	▶ Have the power tool checked by a trained electrical specialist and the carbon brushes replaced if necessary.
No hammering action.	The power tool is too cold.	▶ Bring the tip of the drill bit into contact with the working surface, switch the rotary hammer on and allow it to run. If necessary, repeat the procedure until the hammering mechanism begins to operate.

Trouble or fault	Possible cause	Action to be taken
No hammering action.	The function selector switch is set to "Rotary drilling only"  .	▶ Set the function selector switch to the "Hammer drilling" position  .
	Contact pressure too low.	▶ Press harder to increase contact pressure so that hammer mechanism cuts in.
The combihammer doesn't achieve full power.	The gauge (cross section) of the extension cord conductors is inadequate.	▶ Use an extension cord with an adequate conductor cross section.
	The control switch is not fully pressed.	▶ Press the control switch as far as it will go.
	The tool has been set to reverse rotation.	▶ Set the tool to forward rotation.
	Voltage from generator is too low.	▶ Make sure that voltage rating of electricity supply is correct.
The drill bit doesn't rotate.	The function selector switch is not engaged or is in the  "Chiseling" or  "Chisel adjustment" position.	▶ Set the function selector switch to "Drilling without hammering"  or "Hammer drilling"  .
The drill bit can't be released.	The chuck is not pulled back fully.	▶ Pull the chuck back as far as it will go and remove the accessory tool.

10 Disposal

 Most of the materials from which **Hilti** tools and appliances are manufactured can be recycled. The materials must be correctly separated before they can be recycled. In many countries, your old tools, machines or appliances can be returned to **Hilti** for recycling. Ask **Hilti** Service or your Hilti representative for further information.

11 Manufacturer's warranty

- ▶ Please contact your local **Hilti** representative if you have questions about the warranty conditions.

This Product is Certified
Ce produit est homologué
Producto homologado por
Este produto está registrado



HILTI

Hilti Corporation

LI-9494 Schaan

Tel.: +423/234 21 11

Fax: +423/234 29 65

www.hilti.com

Hilti = registered trademark of Hilti Corp., Schaan

Printed: 03.03.2017 | Doc-Nr: PUB / 5324648 / 000 / 01



2143374

Pos. 3 | 20170209